

GÜVEN | ÇELİK HASIR
PANEL ÇİT SİSTEMLERİ
www.guvencelikhasir.com.tr WELDED MESH WIRE - PANEL FENCE SYSTEMS



**GUVEN WELDED MESH WIRE
DECORATIVE PANEL FENCE SYSTEMS**



Dekoratif Panel Çit Sistemleri

Decorative Panel Fence Systems



Decopanel & Double Panel Çit

Decopanel & Double Panel Fence



Helezon Jiletli Tel Uygulama

Helix-Shaped Razor Bladed Wire



Düzlemsel Jiletli Tel Uygulama

Ratwrap Razor Bladed Wire



Bofer Panel Çit

Bofer Panel Fence



Trapez Sac Pano Uygulaması

Sheet Metal Board Application



Ferforje Sistemleri

Wrought Iron Systems



Kafes Tel

Chainlink Fence



Beton Direk Uygulama & Dikenli Teller

Concrete Post Application & Barbed Wires



Panolar

Boards



Kapılar

Gates



Kaynaklı Teller & Tünel Kafes İksa

Welded Wires & Tunnel Metal Construction



Çelik Hasır

Welded Wire Mesh



Bank & Çöp Kovaları

Bench & Litter Bins



Fabrika Uygulamaları

Application For Factory



Hava Alanı & Metrobus Uygulamaları

Airpot & Metrobus Applications



Askeri Savunma Sistemleri

Military Defense Systems



Park & Havuz Uygulamaları

Park & Pool Applications



Hayvan Barınak & Hara Uygulamaları

Animal Sanctuary & Stud Farm Applications



Akaryakıt & Baz İstasyonları

Petrol & Base Stations



Spor Saha Uygulamaları

Sport Field Applications

ESTETİK “GÜVEN”LE BULUŞTU

Betonarme inşaatların vazgeçilmez parçası olan çelik hasır ve panel çit üretimi yapan “GÜVEN ÇELİK HASIR VE PANEL ÇİT SİSTEMLERİ İMALAT SAN. TİC. LTD. ŞTİ.” yeni yapılanması ile sektöre yeni bir soluk, kalite ve GÜVEN getirdi.

GÜVEN Panel Çit Sistemleri, çevre güvenlik çit sistemlerinde yüksek kaliteli, tam ve kesin çözümler sunmak üzere tamamı yerli sermaye ile kurulmuştur. Adapazarı'nda 10.000 m² kapalı alanda, gelişmiş teknolojik makinelerle entegre yapıda üretim yapmakta olan GÜVEN, çevre dostu fabrikasında çekme, doğrultma, kesme, punta kaynak, boyama gibi ürün kalitesi ve standardı ile ilgili tüm işlemleri kendi bünyesinde gerçekleştirmektedir. Adapazarı'nda 1993 yılından bu yana faaliyetini sürdüren firmada 120 kişi çalışmakta ve fiziki güvenlik sistemlerinde her türlü ihtiyaca en uygun çözümü üretmektedir. Firmanın öncelikli hedeflerinden biri; Türk insanının emeğini değerlendirerek, ihracat yapmak böylece ülke ekonomisine katkı sağlamak, ülkemizde sayıları giderek artan ithal malları ile etkin rekabet etmektir. GÜVEN Panel Çit Sistemleri, bu amaçla Satış ve pazarlama birimini yeniden yapılandırarak İstanbul'a taşıdı. Böylece gerek yurtiçinde gerekse yurtdışında agresif bir pazarlama stratejisi güdecek olan firma, profesyonel ve misyon sahibi yönetim ve çalışan kadrosu ile adından sıkça söz ettirecek, sektörün ihtiyacı olan “markalı” ve “garantili” ürün ve servis açığını dolduracaktır.

Satış ve Pazarlama faaliyetinin İstanbul'dan yürütülmesi ile birlikte, yurtiçi ve yurtdışında bayilik alt yapısı konusunda çalışmalar başlatan GÜVEN Panel Çit, konusunda deneyimli uygulama ekipleriyle yalnızca Türkiye nin değil, yurtdışında, özellikle Türk Cumhuriyetlerinde anahtar teslimi projelere de imza atıyor. Bu yapıyla özellikle yurtdışında çalışan Türk inşaat şirketlerinin çelik hasır, panel çit, ferforje, spor sahaları gibi ihtiyaçlarına doğru ve yerinde cevap verebilmektedir.

GÜVEN Panel Çit, dünyanın en gelişmiş fiziki güvenlik sistemlerini üretmekte, güzel ülkemizin her yerinde ve dünyanın bir çok ülkesinde, malzemesi ve montajı dahil olmak üzere tecrübeli ekipleri ile eksiksiz çözümler sunmadaki kalite çizgisini sürekli arttırma arayışı içerisinde. Gerek yeni, gerek lüks gerekse eski olsun, fabrika, konut, ulaşım, tarım ve havacılık, sizin için değerli olan her alanın korunmasında fiziki çözümü GÜVEN ismi ve kalitesi ile sunuyor.

AESTHETICS HAS MET WITH CONFIDENCE

The reorganization of “GUVEN CELIK HASIR VE PANEL CIT SISTEMLERİ İMALAT SAN TIC STI”, which carries out the production of steel mesh and panel fencing that are indispensable parts of reinforced concrete constructions, has brought in a new breath, quality and CONFIDENCE into the sector.

GUVEN Panel Fencing Systems have been set up in order to provide high quality full and effective solutions for peripheral security fencing systems with complete local capital. GUVEN, which is carrying out its production in Adapazari within 10.000 m2 closed area plant and with advanced technology machinery in an integrated structure, carries out all of the operations, like drawing, bending, cutting, welding, painting and which are related to the product quality and the standards, within its body in its plant that is environment friendly. 120 people is employed at the company that is continuing with its activities since 1993 in Adapazari and they produce the most suitable solution in relation to every kind of requirement for physical safety systems. One of the preferential targets of the company is; to export by reclaiming the labour of the Turkish people and therefore provide contribution for the economy of the country and to compete with the imported goods that are increasing in numbers in our country. GUVEN Panel Fencing Systems has moved its sales and marketing department to Istanbul for this aim after it had reorganized it. Therefore, the company, which will follow a aggressive marketing strategy both at home and abroad, will make name for itself frequently with its management and work force, who are professional and who have mission and will fill in the gap of “branded” and “high quality” product and service that the sector is lacking.

GUVEN Panel Fencing, which has started with the activities in relation to the dealership infrastructure at home and abroad since the Sale and Marketing activities is followed from Istanbul, is putting its signature under turn key projects not only in Turkey but at abroad also and especially in Turcic Republics with its application teams that are experienced in their own fields. It can provide answers especially for Turkish construction companies, which are operating abroad, with this structure of itself in right way and in applicable way for their requirements like, steel mesh, panel fencing, wrought iron and sport fields. GUVEN Panel Fencing manufactures the most advanced physical security systems of the world and it is in search of continuously increasing its quality line for providing complete solutions in every corner of our beautiful country and in many countries of the world with its experienced teams inclusive of the material and the assembly. It is providing the physical solution for every kind of area, whether it is new or luxurious or whether it is old and for areas that are valuable for you as the plant, building, transport, agriculture and livestock farming with the name and quality of GUVEN.



Ali İhsan GÜVEN
Yönetim Kurulu Başkanı

Kalite Sertifikaları

Quality Certificates



Referanslar

References

- Referans / Reference
- ▲ Fabrika / Factory
- Bölge Müdürlüğü / Office

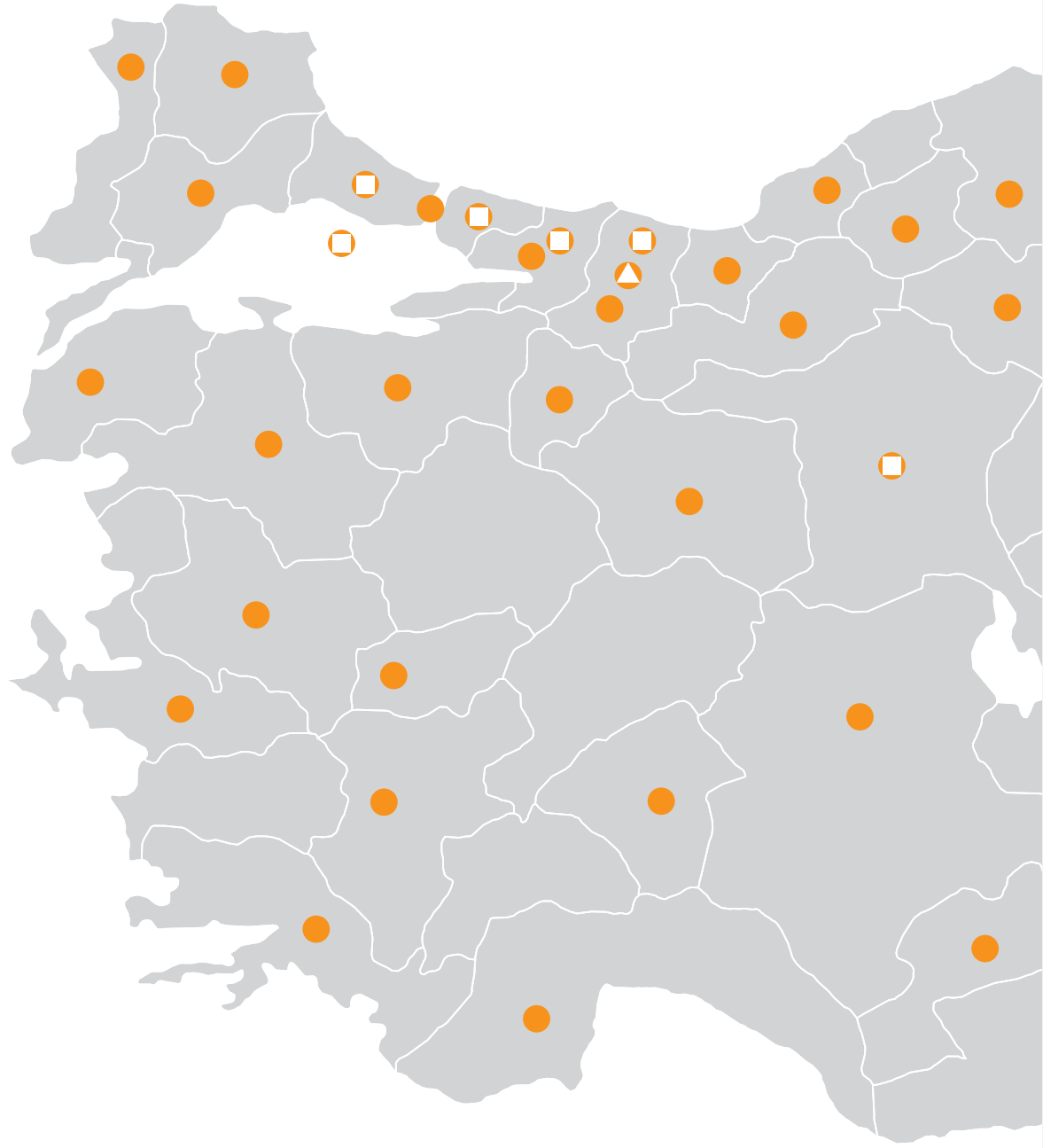

Referanslarımızdan Bazıları

- A.A. Grup
- Alarko A.Ş.
- Şişecam A.Ş.
- Baytur İnş. Taah. A.Ş.
- Fi Yapı
- Türk Hava Yolları
- İstanbul Büyükşehir Belediyesi
- Adapazarı Büyükşehir Belediyesi
- TÜV Türk Araç Muayene İstasyonları
- Oyak Holding
- Bautek A.Ş.
- Ferhat İnşaat
- Teknogon A.Ş.
- Özkartallar İnşaat A.Ş.
- Ülker Holding
- Ferrol
- Simbo Elektrikli Ev Aletleri A.Ş.

- Kuhu Grup
- TOKİ
- Kocaeli Büyükşehir Belediyesi
- Yalova Belediyesi
- Özdeş
- Belen İnşaat Turizm A.Ş.
- Cengiz İnşaat San. Tic. A.Ş.
- İçtaş San. Tic. A.Ş.
- Kismak A.Ş.
- Temsa
- Sapanca Onduline Fabrikası
- Sakarya 1. 2. Organize San. Bölgesi
- Yaren Orman Ürünleri
- Adasu Aritma Tesisleri
- Otokar A.Ş.
- Sanko A.Ş.
- Uşak Belediyesi

İhracatlarımız

- KKTC
- Romanya
- Kırgızistan
- Bulgaristan
- Almanya
- Irak
- İran
- Ukrayna
- Rusya
- Arnavutluk
- Azerbaycan
- Kazakistan
- Sudan
- Ürdün

Dekoratif Panel it Sistemleri

Decorative Panel Fence Systems



Kutu Profil Direk Panel it (Panel Fence with Profile Post)

Kutu Profil direkli panel it galvaniz zeri 100 mikron elektrostatik fırın boya kaplıdır. Ayrıca Plascoat elektrostatik fırın boya ile üretim yapılabilmektedir. Standart rengi Ral 6005 yeşil olmakla beraber, tüm ral renklerde üretilebilmektedir. Profil direk bağlantı aparatları Sarmal tip UV korumalı polyemitten üretilmektedir.

The Panel fencing with Box Section Profile pole is powder coated with 100 micron thickness over galvanization. Although its standard colour is green according to RAL 6005, it can be produced with all of the RAL colours. The profile connection apparatus are manufactured from coiled type polyamide with UV protection.

Uygulamalar Applications



Panellerimiz 1800 saat tuz testine tabi tutularak test edilmiştir.
Our panels have been tested by applying them to the 1800 hours salt test.

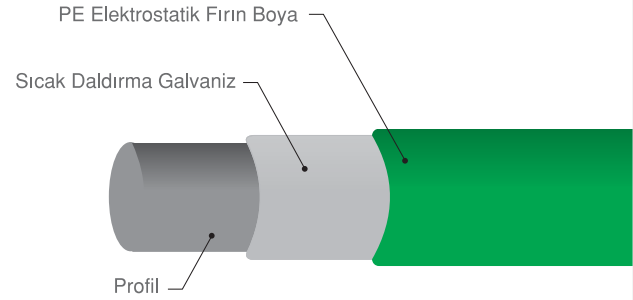
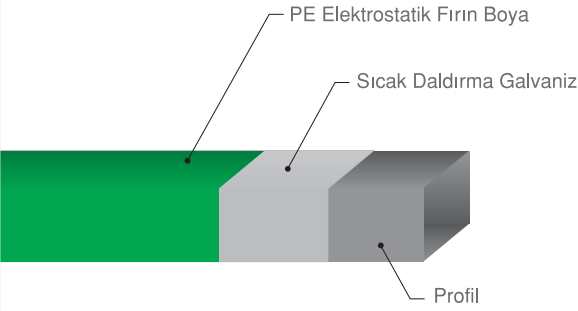
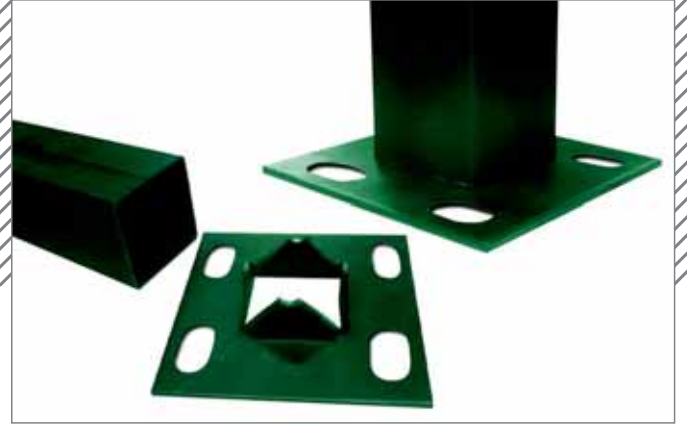

Elektrostatik boyalı panel çit çap 4,5mm
Panel Fence 4,5mm Elektro Static Painted

Profile Post 50x50x2mm
kutu profil

Tel Çapı Wire Diameter	Q4,50mm+5mm
Göz Aralığı Mesh Size	5x10-5x15-5x20
Dikmeler Perpendicular	50x50x2mm Profil+60x60x2mm
Yükseklik Height	60cm/80cm/100cm/120cm/150cm/200cm
Genişlik Widht	250cm
Özellikleri Specifications	Galvaniz üzeri elektirostatik boyalı Galvanized over electrostatic painted

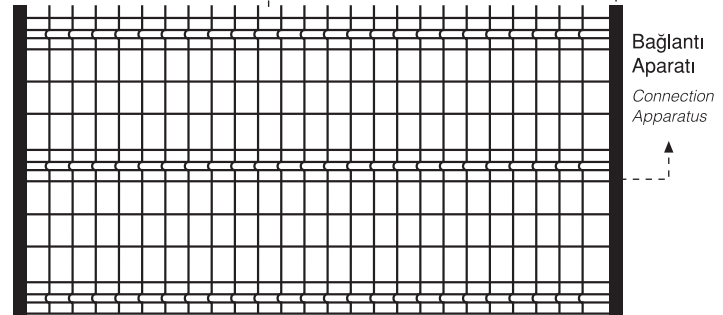

Uygulamalar

Application



Uygulama Amacı (Application Purposes)

Dekoratif panel çit sistemleri sizin için değerli olan alanları güvenlik altına almak amacıyla uygulanmaktadır. Panel çit sistemleri Toprak, Beton, Duvar ve Kademeli Duvar v.b zeminler üzerine uygun ve kolay bir şekilde montaj edilebilmektedir.

The decorative panel fencing systems are applied in order to keep the areas, which are valuable for you, under security. The panel fencing systems can be assembled on floors like, soil, concrete, wall and sectioned wall, etc in suitable and easy manner.

Uygulamalar Applications

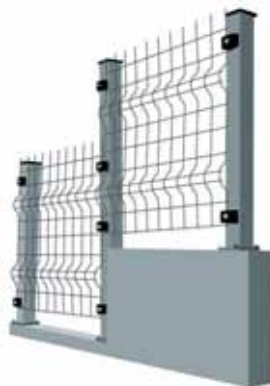

Kademe Direkli Uygulama





Uygulamalar

Application



Uygulama Amacı (Application Purposes)

Dekoratif panel çit sistemleri sizin için değerli olan alanları güvenlik altına almak amacıyla uygulanmaktadır. Panel çit sistemleri Toprak, Beton, Duvar ve Kademeli Duvar v.b zeminler üzerine uygun ve kolay bir şekilde montaj edilebilmektedir.

The decorative panel fencing systems are applied in order to keep the areas, which are valuable for you, under security. The panel fencing systems can be assembled on floors like, soil, concrete, wall and sectioned wall, etc in suitable and easy manner.

Uygulamalar

Applications





Decopanel & Double Panel Çit

Decopanel & Double Panel Fence



Double Panel Çit Sistemleri / Double Panel Fence Systems

Tel Çapı Wire Diameter	Göz Aralığı Mesh Size	Dikmeler Post	Kutu Profil Profile Post	Boru Tubular Post	Yükseklik Height	Genişlik Width	Özellikleri Specifications
5 x 6 mm	5 x 15	Profil veya Boru	50 x 50 x 2 mm	60 x 2 mm	1.00 mt	2.50 mt	Galvaniz üzeri elektrostatik boyalı
6 x 8 mm	5 x 20		60 x 60 x 2 mm		1.50 mt		
			2.00 mt				

Uygulamalar
Applications



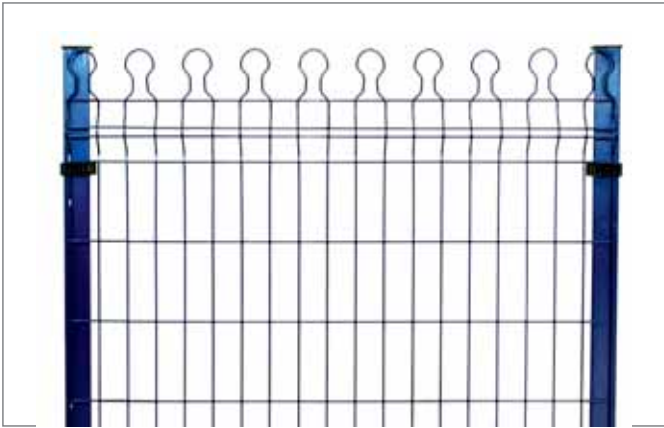
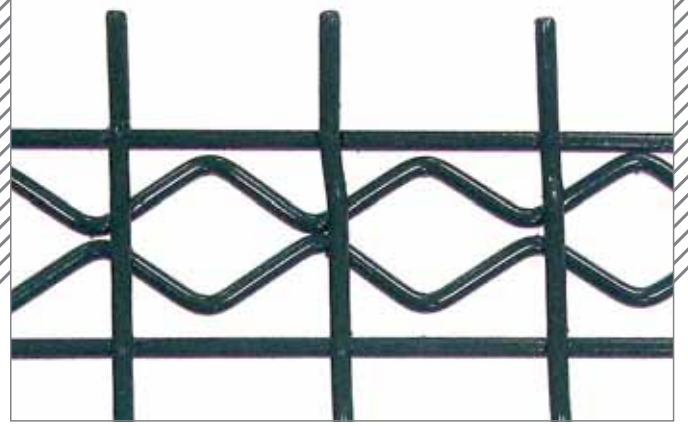

Helezon Jiletli Tel Uygulama

Helix-Shaped Razor Bladed Wire



Uygulama Amacı (Application Purposes)

Stratejik koruma alanlarının güvenliğini en üst seviyede olmasını sağlamak amacıyla uygulanmaktadır.

It is applied in order to provide for the top level security for fields that have strategic protection security.

Uygulamalar Applications



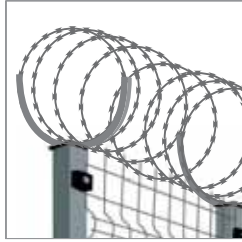

Helezon Şeklinde Bariyerlerin Teknik Bilgileri
Technical information and deployment distance
f embankment with helix shape

Jiletli Tel Kesiti Razor Wire Section

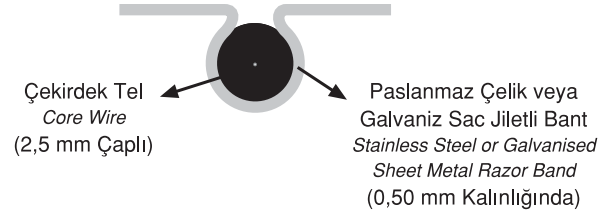

Çap Ölçüleri Dimensions	Ø 97 cm	Ø 80 cm	Ø 75 cm	Ø 70 cm	Ø 60 cm	Ø 45 cm	Ø 30 cm
Sarım Adedi Number of Windings	56 (~72'de klipsli)	56 (~72'de klipsli)	56 (~72'de klipsli)	56 (~72'de klipsli)	56 (~72'de klipsli)	56 (~120'de klipsli)	56 (~120'de klipsli)
Azami Açılma Mesafesi Maximum Opening Distance	15 m	12 m	11 m	10 m	9 m	7 m	6 m
İdeal Açılma Mesafesi Ideal Opening Distance	10 m	8,5 m	8 m	7,5 m	6,5 m	6 m	5 m
Rulo Ağırlığı Weight of the Roll	14,7 kg (± 0,8 kg)	12,5 kg (± 0,5 kg)	11,4 kg (± 0,5 kg)	10,5 kg (± 0,4 kg)	9,3 kg (± 0,4 kg)	7 kg (± 0,3 kg)	5 kg (± 0,3 k)



Düzlemsel Jiletli Tel Uygulama

Ratwrap Razor Bladed Wire



Uygulama Amacı (Application Purposes)

Stratejik koruma alanlarının güvenliğinin en üst seviyede olmasını sağlamak amacıyla uygulanmaktadır.

It is applied in order to provide for the top level security for fields that have strategic protection security.

Uygulamalar Applications



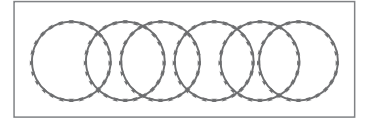
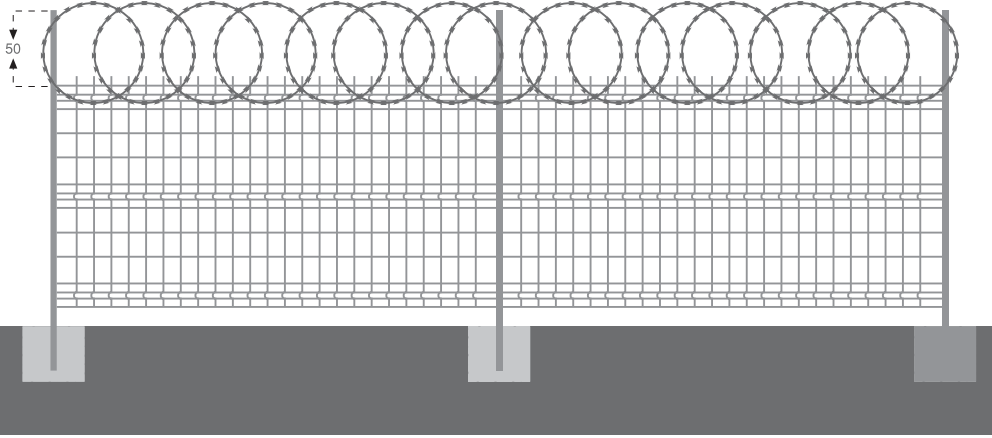

Çap Diameter	450 mm - 600 mm - 900 mm
Kaplama Coat	AISI 430 - 304 - Sıcak daldırma galvaniz AISI 430 - 304 - Hot Dip Galvanise
Uzunluk Length	3 m - 10 m (veya istenen özel ölçülerde)
Ağırlık Weight	1 kg / metre (0.1 kg)



Bofer Panel Çit

Bofer Panel Fence



Uygulama Amacı (Application Purposes)

Her konseptte uygun dekoratif Güven Bofer Panel çitlerimizle daha modern bir çizgi yakalayabilirsiniz. Katalogtaki modellerimiz haricinde istenilen modellerde üretim ve uygulama yapılabilmektedir.

You can catch more modern line with our Guven Bofer Panel fencing, which are suitable for every concept. Production and application can be made for models that are outside of our models contained in our catalogue.

Uygulamalar Applications



Trapez Sac Pano Uygulaması

Sheet Metal Board Application



Uygulama Amacı (Application Purposes)

Trapez sac genellikle okul, fabrika, konut ve inşaat sahasında şantiye güvenliğini seyyar veya sabit olarak olası iş kazalarına karşı korunmasını sağlamak amacıyla kullanılmaktadır.

The trapezium sheet metal is generally used for the safety of the site for school, plant, housing and construction sites as mobile or fixed protection against possible accidents during work.

Uygulamalar Applications



Kalite Yönetim Sistemi
TS EN ISO/IEC 17021
AS-0022-YS



Ferforje Sistemleri

Wrought Iron Systems



Uygulama Amacı (Application Purposes)

Ferforje sistemlerimizde elektrostatik fırın boya kullanılarak üretilmektedir. Katalogtaki modellerimiz haricinde istenilen modellerde üretim ve uygulama yapılabilmektedir.

Our wrought iron systems are also manufactured by using powder coating method. Production and application can be made for models that are outside of our models contained in our catalogue.

Uygulamalar Applications





Kafes Tel

Chainlink Fence

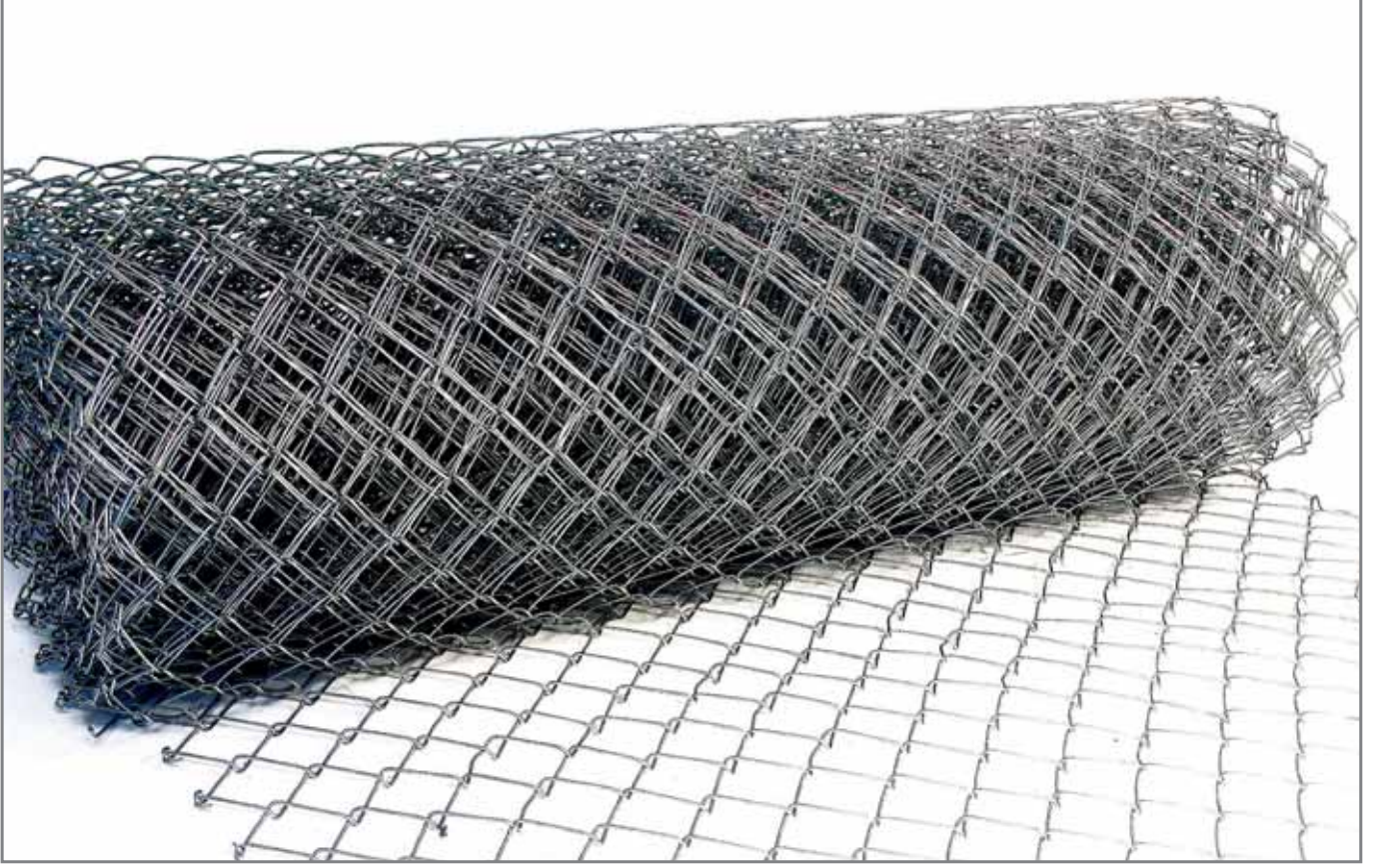

Galvaniz Kafes Tel <i>Galvanized Chainlink Wire</i>			PVC Kafes Tel <i>PVC Chainlink Wire</i>	
Tel Kalınlığı <i>Wire Diam</i>	Göz Aralıkları <i>Mesh Size</i>	Galvaniz Oranı <i>Galvanized Ratio</i>	Tel Kalınlığı <i>Wire Diam</i>	Göz Aralıkları <i>Mesh Size</i>
2		100 gr/m ²	3	
2.5	40x40		3.5	40x40
2.7	50x50			50x50
3	60x60			60x60
3.5	70x70			70x70

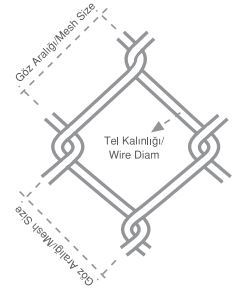

Uygulamalar
Applications



Genellikle tarım arazilerinde çevre güvenliği amaçlı uygulanmaktadır.
They are usually used at the agricultural grounds for security of the surround.



Boru Direkli Tel Çit Üzeri Dikenli Tel Uygulaması (200 cm)
Barbed Wire Application over Wire Fence With Pipe Pole (200 cm)

Boru Direkli Tel Çit Üzeri Helezonik Jiletli Tel Uygulaması
Spiral Razor Wire Application over Wire Fence With Pipe Pole

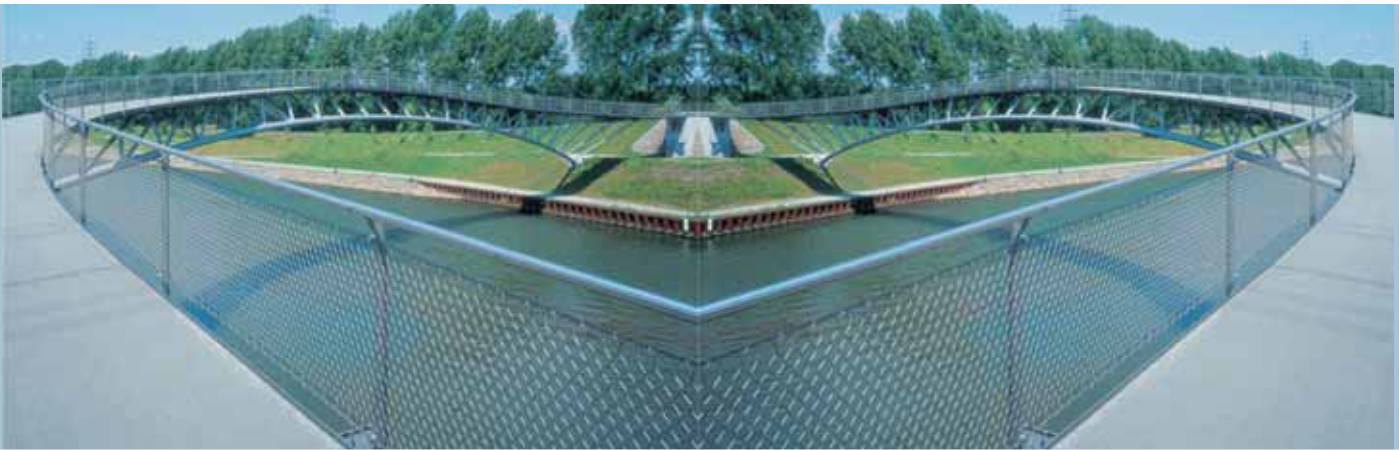
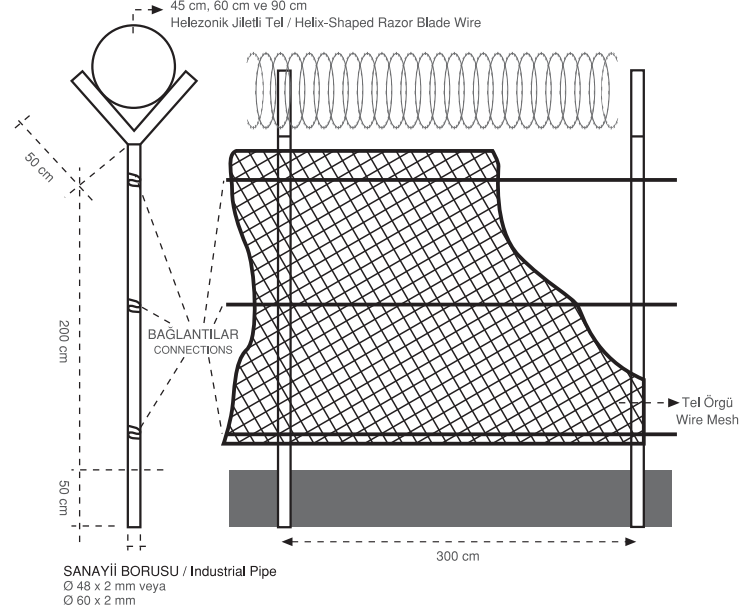
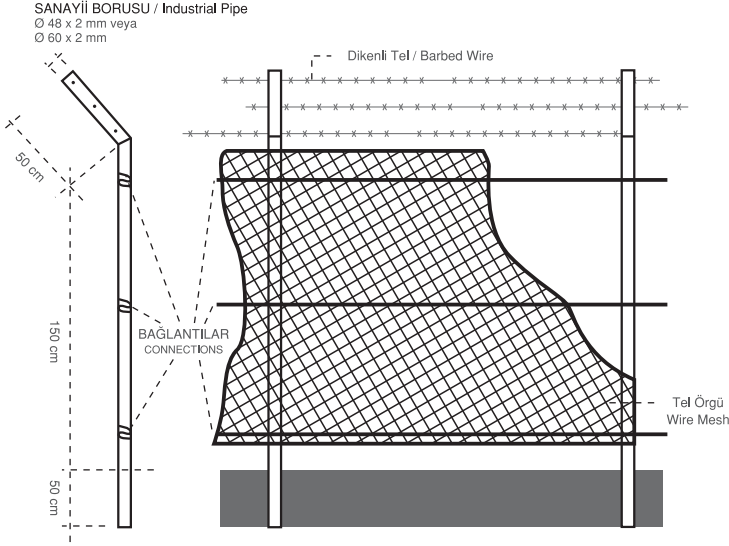

Beton Direk Uygulama & Dikenli Teller

Concrete Post Application & Barbed Wires



Beton Direkler
Concrete Post

Cinsi Type	Yükseklik Height	Taban Kesit Base	Tepe Kesit Top	Delik Sayısı Number Of Holes	Donatı Concrete Specification	Ağırlık Weight
Nato Tipi Nato Type	3.50mt	10x14cm	10x10cm	9+3	4xØ10mm	120kg/adet
	3.00mt	10x14cm	10x10cm	7+3	4xØ8mm	90kg/adet
	2.50mt	10x12cm	9x9cm	10	5xØ7mm	50kg/adet
	2.40mt	10x14cm	9x10cm	7+3	4xØ7mm	60kg/adet
Düz Direk Flat Type	2.00mt	9x10cm	9x9cm	7	4xØ7mm	43kg/adet
	2.50mt	10x12cm	9x9cm	10	5xØ7mm	50kg/adet
	2.00mt	9x10cm	9x9cm	7	4xØ7mm	43kg/adet
	1.50mt	10x12cm	9x9cm	10	5xØ7mm	40kg/adet

Uygulamalar
Applications

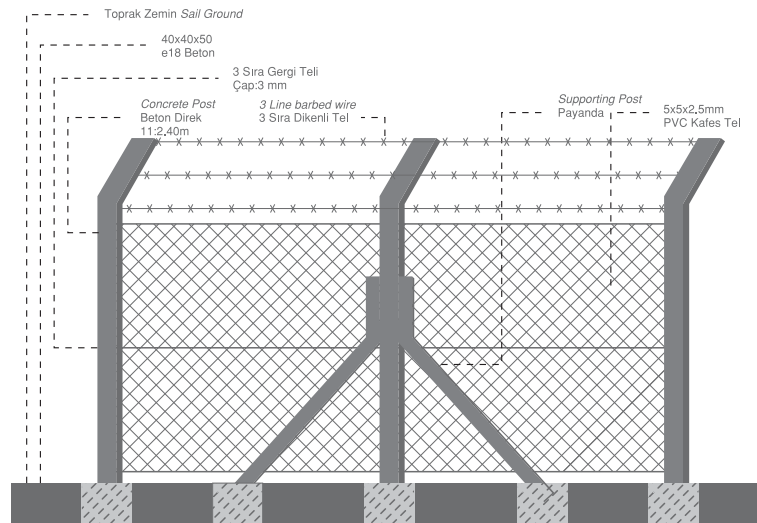

Genellikle tarım arazilerinde çevre güvenliği amaçlı uygulanmaktadır.
They are usually used at the agricultural grounds for security of the surround.



Cinsi Type	Diken Teli Barbed Wire	Hat Teli Line Wire	Kg / Metre Kg / meter	Rulo Sarım Roll Couling
Sıcak Daldırma Galvaniz	2,00 mm	2,50 mm	1 kg / 8 mt	125 mt
Sıcak Daldırma Galvaniz	1,50 mm	2,00 mm	1 kg / 30 mt	250 mt
PVC	2,00 mm	2,50 mm	1 kg / 8 mt	125 mt



Panolar

Boards



Çerçeve İçi Pano Sistemleri Welded Mesh On Board Systems

Uygulama Application	Standart Ölçüler Standart Sizes	Dikmeler Posts	Çerçeve Frame	Çerçeve İçi Luside Frame	Kaplama Coating
Köşe Bent Pano Board	1x2-1.5x2-2x2	Kutu/Boru Profil Profile/tubular post	40x40x4mm	Çelik Hasır	Sıcak Daldırma Galvanizli, Hot Dip Galvanized
Boru Pano Tubular Board	1x2-1.5x2-2x2	50x50x2mm 60x60x2mm	50x50x5mm 51x2mm Boru	Kafes Teller	Elektro Galvaniz Üzeri Electro Galvanized Over
Mızraklı Pano Panel With Spear		40x60x2mm 51x2/60x2mm	60x2mm Boru		Statik Boyalı veya Static Painted Antipas + Yağlı Boyalı Or Anti-rust + Paint

Uygulamalar Applications



Tercihinize uygun farklı dizaynlarda estetik görünümü sağlamak için uygulanmaktadır.
They are applied in order to provide the aesthetic appearance for different designs that are in line with your preference.

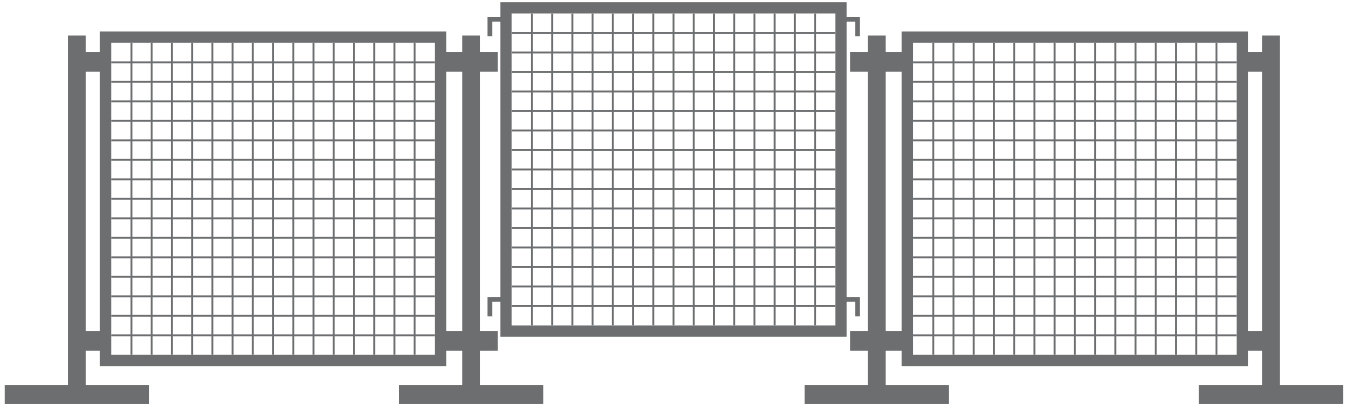

Kapılar

Gates



Uygulama Amacı (Application Purposes)

Dekoratif panel çit yada kafes telle güvenlik altına aldığınız alanlara dizayn olarak uyum sağlayan ve bu alanlara giriş çıkışınızı sağlamak için uygulanmaktadır.

It is applied to blend in with the design and to provide access for the areas, which you have secured with decorative panel fencing or with mesh wires.

Uygulamalar

Applications



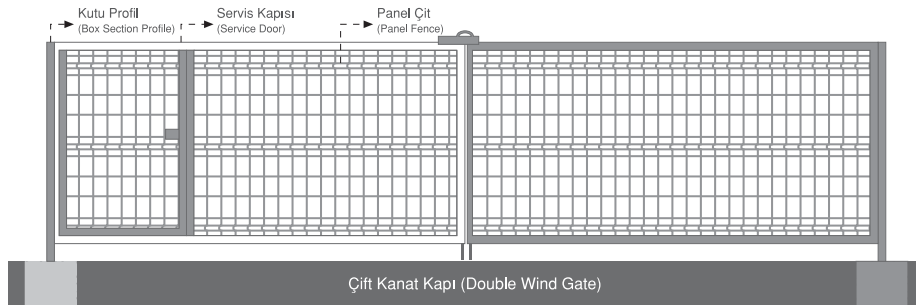
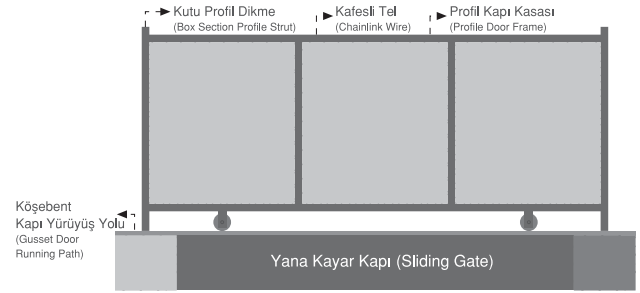
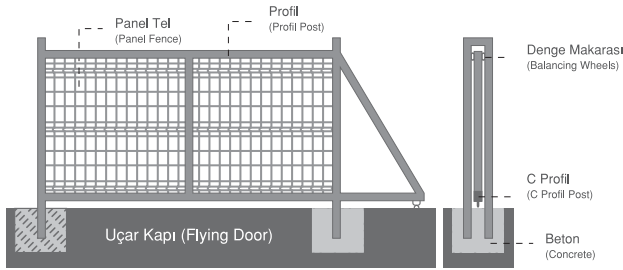

Kaynaklı Teller & Tünel Kafes İksa

Welded Wires & Tunnel Metal Construction



Göz Aralığı Mesh Size	Tel Kalınlığı(mm) Wire Diam	Ebat (mm) Size
20x20	2.80	100x200
30x30	2.80-4.00	100x200
40x40	4.00-4.50-5.00	100x200
50x50	4.00-4.50-5.00	100x200
60x60	4.00-4.50-5.00	100x200
50x100	4.00-4.50-5.00	100x200
50x100	4.00-4.50-5.00	100x200
50x150	4.00-4.50-5.00	100x200
50x150	4.00-4.50-5.00	150x200

Uygulamalar
Applications



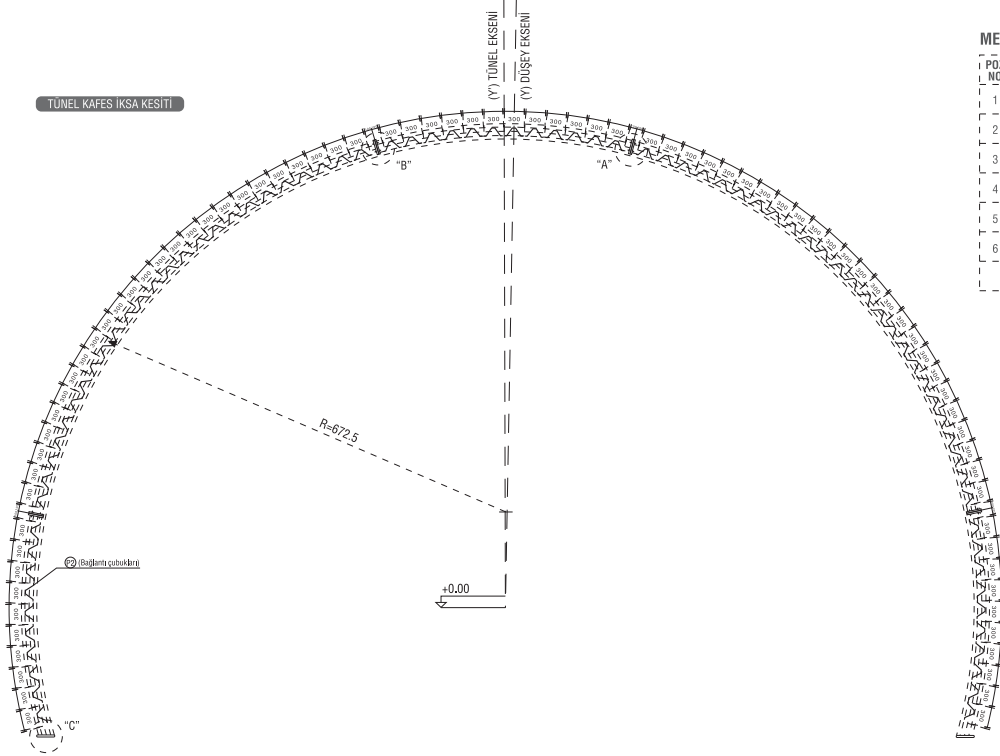

METRAJ TABLOSU

POZ NO	PARÇA ADI	ADET	HACMI m ³	BOY m.	BİRİM AĞIRLIK	TOPLAM AĞIRLIK
1	Ø32 NERVÜRLÜ DEMİR	3	-	25,61	6,31 kg/m	494,80 kg
2	Ø12 BAŞLI ANTI ÇUBUK	72	-	1,364	0,888 kg/m	87,21 kg
3	KÖŞEBENT	20	1x10x10	0,222	15,10 kg/m ²	67,04 kg
4	TABAN PLAKASI	2	40x45x1	-	7850 kg/m ³	28,26 kg
5	M16 CIVATA SOMUN(DİNE912)	16	-	-	0,156 kg/adet	2,50 kg
6	Ø34 DEMİR BORU	66	-	0,05	3,14 kg/m	10,36 kg
TOPLAM						680,17 kg

Çelik Hasır

Welded Wire Mesh

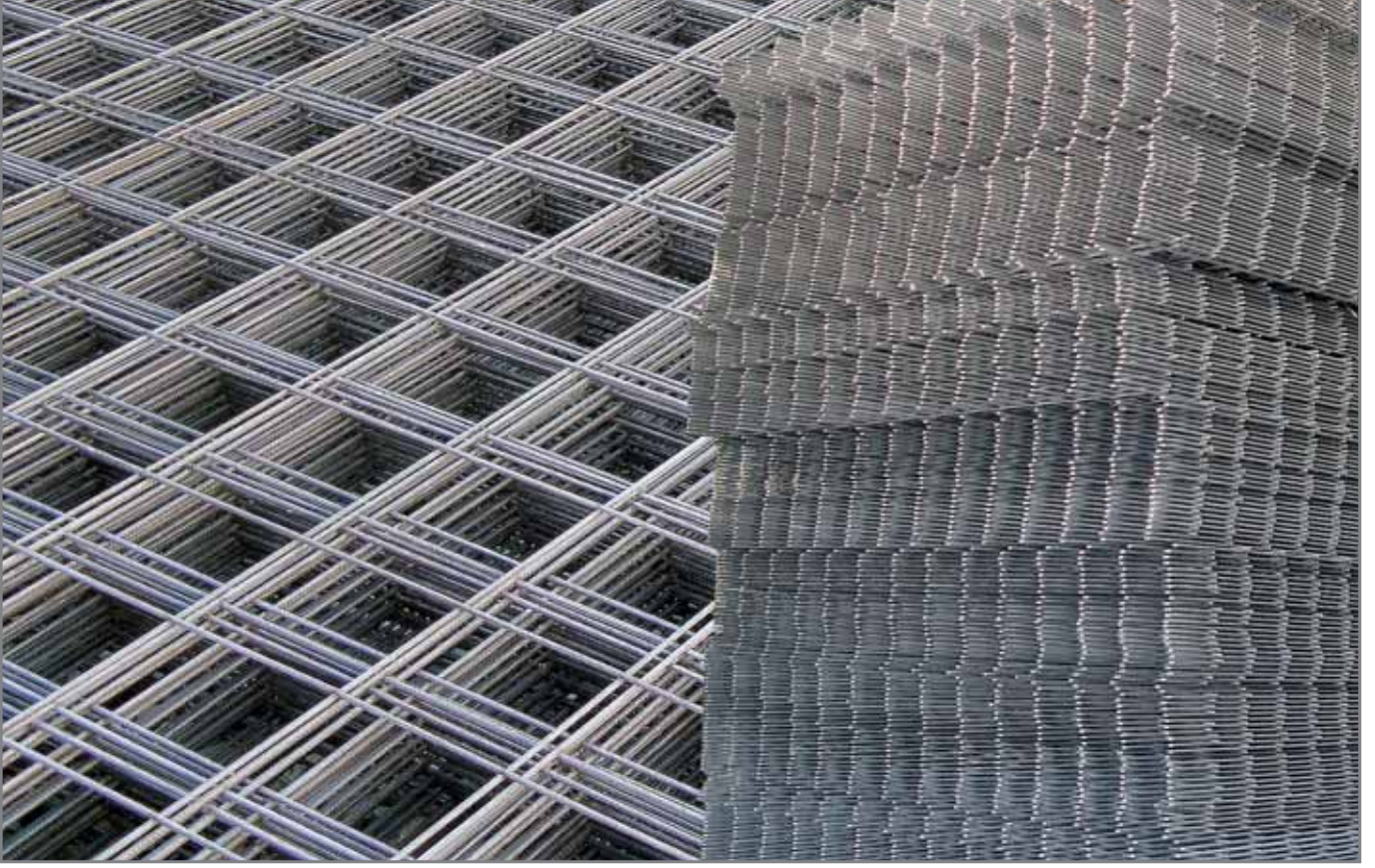

Uygulama Amacı (Application Purposes)

Yapı malzemesi olarak çelik hasır, özellikle döşemelerde, perdelerde, istinat duvarlarında, temellerde, saha betonlarında, beton yollarda tünel ve galerilerde, kanal ve kanaletlerde kullanılmaktadır. Bunların dışında bahçe çiti, korkuluk ve asma tavanlar içinde kullanılan çeşitleri de mevcuttur.

Welded wire mesh is successfully and economically used in all assortments of concrete structures, such as slabs, walls, webs, beams, and column footing, highways, tunnels and galleries. They are especially suitable for concrete reinforcement. Apart from these, there are other available welded wire mesh types which are used for garden fencing safety railings and suspended ceilings. According to the customer demand, these can be manufactured as hot dipped galvanized and polyester painted.

Uygulamalar Applications



Çelik Hasır üretimi TS 4559, DIN 488,BS 4483, ASTM-A 497 normlarına uygun olarak üretmektedir.
Welded wire mesh is produced within TS 4559, DIN 488,BS 4483, ASTM-A 497 standarts.

Hasır Tipi	Boyu (cm)	Eni (cm)	Çubuk Çapı Boyu (mm)	Çubuk Çapı Eni (mm)	Göz Aralığı Boyu (cm)	Göz Aralığı Eni (cm)	Filiz Boyu (cm)	Filiz Eni (cm)	Çubuk Sayısı Boyu (unit)	Çubuk Sayısı Eni (unit)	Hasır Ağırlığı Kg./Unit	Hasır Ağırlığı Kg./m ²	Hasır Tipi	Boyu (cm)	Eni (cm)	Çubuk Çapı Boyu (mm)	Çubuk Çapı Eni (mm)	Göz Aralığı Boyu (cm)	Göz Aralığı Eni (cm)	Filiz Boyu (cm)	Filiz Eni (cm)	Çubuk Sayısı Boyu (unit)	Çubuk Sayısı Eni (unit)	Hasır Ağırlığı Kg./Unit	Hasır Ağırlığı Kg./m ²
R106	500	215	4.5	4.5	15	25	12.5	2.5	15	20	14.73	1.37	Q295/158	500	215	7.5	5.5	15	15	17.5	2.5	15	32	38.84	3.61
R131	500	215	5.0	5.0	15	25	12.5	2.5	15	20	18.19	1.69	Q295/188	500	215	7.5	6.0	15	15	17.5	2.5	15	32	41.28	3.84
R158	500	215	5.5	5.0	15	25	12.5	2.5	15	20	20.62	1.92	Q295/221	500	215	7.5	6.5	15	15	17.5	2.5	15	32	43.93	4.09
R188	500	215	6.0	5.0	15	25	12.5	2.5	15	20	23.27	2.17	Q295/257	500	215	7.5	7.0	15	15	17.5	2.5	15	32	46.80	4.35
R221	500	215	6.5	5.0	15	25	12.5	2.5	15	20	26.16	2.43	Q295/295	500	215	7.5	7.5	15	15	17.5	2.5	15	32	49.87	4.64
R257	500	215	7.0	5.0	15	25	12.5	2.5	15	20	29.29	2.72	Q317/131	500	215	5.5d	5.0	15	15	17.5	2.5	22	32	31.12	2.89
R295	500	215	7.5	5.0	15	25	12.5	2.5	15	20	32.64	3.04	Q317/158	500	215	5.5d	5.5	15	15	17.5	2.5	22	32	33.35	3.10
R317d	500	215	5.5d	5.0	15	25	12.5	2.5	26	20	30.87	2.87	Q317/188	500	215	5.5d	6.0	15	15	17.5	2.5	22	32	35.79	3.33
R335	500	215	8.0	5.0	15	25	12.5	2.5	15	20	36.22	3.37	Q317/221	500	215	5.5d	6.5	15	15	17.5	2.5	22	32	38.44	3.58
R377	500	215	8.5	5.0	15	25	12.5	2.5	15	20	40.04	3.72	Q317/257	500	215	5.5d	7.0	15	15	17.5	2.5	22	32	41.30	3.84
R377d	500	215	6.0d	5.0	15	25	12.5	2.5	26	20	35.48	3.30	Q317/295	500	215	5.5d	7.5	15	15	17.5	2.5	22	32	44.38	4.13
R443d	500	215	6.5d	5.5	15	25	12.5	2.5	26	20	41.88	3.90	Q335/221	500	215	8.0	6.5	15	15	17.5	2.5	15	32	47.52	4.42
R513d	500	215	7.0d	6.0	15	25	12.5	2.5	26	20	48.82	4.54	Q335/257	500	215	8.0	7.0	15	15	17.5	2.5	15	32	50.38	4.69
R589d	500	215	7.5d	6.5	15	25	12.5	2.5	26	20	56.29	5.24	Q335/295	500	215	8.0	7.5	15	15	17.5	2.5	15	32	53.45	4.97
TR158	500	215	5.0d	5.5	25	15	17.5	7.5	9	32	19.77	1.84	Q335/335	500	215	8.0	8.0	15	15	17.5	2.5	15	32	56.74	5.28
TR188	500	215	5.0d	6.0	25	15	17.5	7.5	9	32	22.21	2.07	Q335/378	500	215	8.0	8.5	15	15	17.5	2.5	15	32	60.24	5.60
TR221	500	215	5.0d	6.5	25	15	17.5	7.5	9	32	24.86	2.31	Q335/424	500	215	8.0	9.0	15	15	17.5	2.5	15	32	63.95	5.95
TR257	500	215	5.0d	7.0	25	15	17.5	7.5	9	32	27.72	2.58	Q377/131	500	215	6.0d	5.0	15	15	17.5	2.5	22	32	35.02	3.26
TR295	500	215	5.0d	7.5	25	15	17.5	7.5	9	32	30.80	2.86	Q377/158	500	215	6.0d	5.5	15	15	17.5	2.5	22	32	37.25	3.46
TR335	500	215	5.0d	8.0	25	15	17.5	7.5	9	32	34.08	3.17	Q377/188	500	215	6.0d	6.0	15	15	17.5	2.5	22	32	39.69	3.69
Q84/84	500	215	4.0	4.0	15	15	17.5	2.5	15	32	14.19	1.32	Q377/221	500	215	6.0d	6.5	15	15	17.5	2.5	22	32	42.34	3.94
Q106/106	500	215	4.5	4.5	15	15	17.5	2.5	15	32	17.95	1.67	Q377/257	500	215	6.0d	7.0	15	15	17.5	2.5	22	32	45.20	4.20
Q131/131	500	215	5.0	5.0	15	15	17.5	2.5	15	32	22.16	2.06	Q377/295	500	215	6.0d	7.5	15	15	17.5	2.5	22	32	48.28	4.49
Q158/131	500	215	5.5	5.0	15	15	17.5	2.5	15	32	24.59	2.29	Q443/158	500	215	6.5d	5.5	15	15	17.5	2.5	22	32	41.49	3.86
Q158/158	500	215	5.5	5.5	15	15	17.5	2.5	15	32	26.82	2.49	Q443/188	500	215	6.5d	6.0	15	15	17.5	2.5	22	32	43.92	4.09
Q188/131	500	215	6.0	5.0	15	15	17.5	2.5	15	32	27.25	2.54	Q443/221	500	215	6.5d	6.5	15	15	17.5	2.5	22	32	46.58	4.33
Q188/158	500	215	6.0	5.5	15	15	17.5	2.5	15	32	29.48	2.74	Q443/257	500	215	6.5d	7.0	15	15	17.5	2.5	22	32	49.44	4.60
Q188/188	500	215	6.0	6.0	15	15	17.5	2.5	15	32	31.92	2.97	Q443/295	500	215	6.5d	7.5	15	15	17.5	2.5	22	32	52.51	4.89
Q221/131	500	215	6.5	5.0	15	15	17.5	2.5	15	32	30.14	2.80	Q513/188	500	215	7.0d	6.0	15	15	17.5	2.5	22	32	48.50	4.51
Q221/158	500	215	6.5	5.5	15	15	17.5	2.5	15	32	32.37	3.01	Q513/221	500	215	7.0d	6.5	15	15	17.5	2.5	22	32	51.15	4.76
Q221/188	500	215	6.5	6.0	15	15	17.5	2.5	15	32	34.81	3.24	Q513/257	500	215	7.0d	7.0	15	15	17.5	2.5	22	32	54.02	5.02
Q221/221	500	215	6.5	6.5	15	15	17.5	2.5	15	32	37.46	3.48	Q513/295	500	215	7.0d	7.5	15	15	17.5	2.5	22	32	57.09	5.31
Q257/131	500	215	7.0	5.0	15	15	17.5	2.5	15	32	33.26	3.09	Q589/221	500	215	7.5d	6.5	15	15	17.5	2.5	22	32	56.07	5.22
Q257/158	500	215	7.0	5.5	15	15	17.5	2.5	15	32	35.49	3.30	Q589/257	500	215	7.5d	7.0	15	15	17.5	2.5	22	32	58.93	5.48
Q257/188	500	215	7.0	6.0	15	15	17.5	2.5	15	32	37.93	3.53	Q589/295	500	215	7.5d	7.5	15	15	17.5	2.5	22	32	62.01	5.77
Q257/221	500	215	7.0	6.5	15	15	17.5	2.5	15	32	40.58	3.77	Q670/257	500	215	8.0d	7.0	15	15	17.5	2.5	22	32	64.19	5.97
Q257/257	500	215	7.0	7.0	15	15	17.5	2.5	15	32	43.44	4.04	Q670/335	500	215	8.0d	8.0	15	15	17.5	2.5	22	32	70.55	6.56
Q295/131	500	215	7.5	5.0	15	15	17.5	2.5	15	32	36.62	3.41													

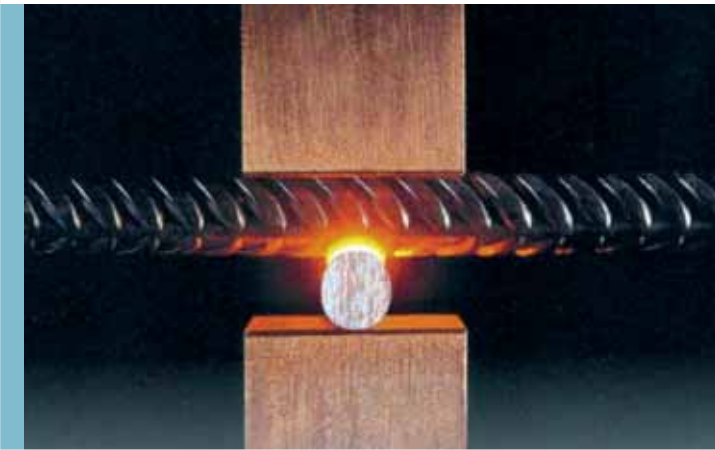

Bank & Çöp Kovaları

Bench & Litter Bins

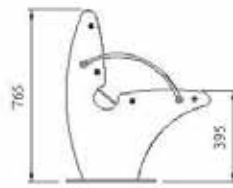
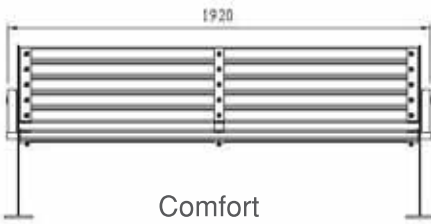

Uygulamalar
Applications



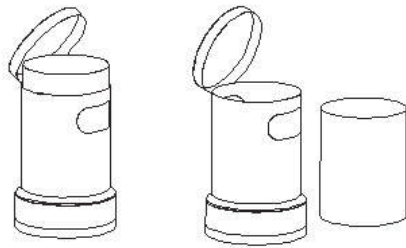
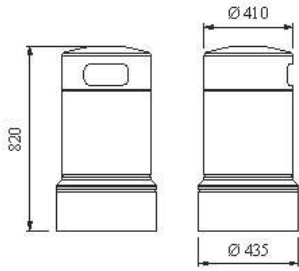

Yuvarlak Tip Çöp Kovası
Round Type Litter Bin

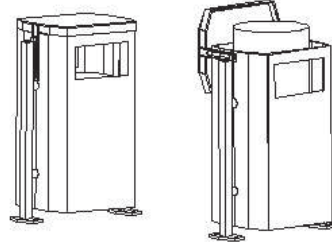
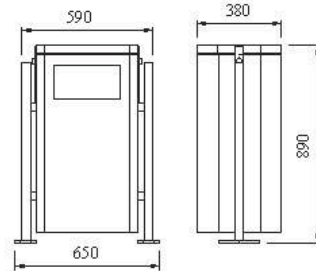

H Tipi Çöp Kovası
H Type Litter Bin

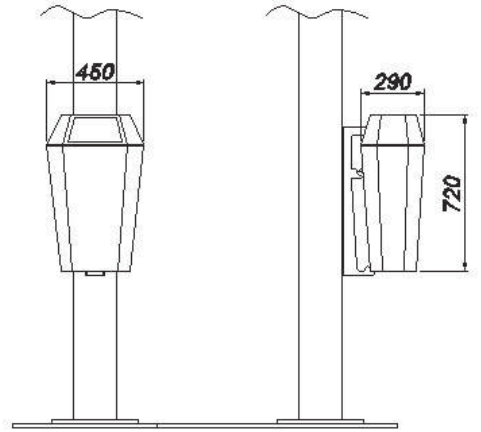

Prizmatik Tip Çöp Kovası
Prismatic Type Litter Bin



Fabrika Uygulamaları

Application For Factory



Uygulama Amacı (Application Purposes)

Fabrika çevre güvenlik amaçlı, fabrika içerisinde ise makina parkurları ve çalışan personelin iş güvenliğini sağlamak amacıyla kullanılmaktadır.

It is used for the plant ground security and for protecting the machinery and the work force in order to provide work safety inside of the plant.

Uygulamalar Applications





Fabrika içi makina parkuru güvenlik alanı
Machinery safety area inside of the plant.



Hava Alanı & Metrobus Uygulamaları

Airpot & Metrobus Applications



Uygulama Amacı (Application Purposes)

Hava alanı ve Metrobüs gibi toplu taşımacılık alanlarını içerden ve dışardan gelebilecek her türlü tehlikeye karşı koruma altına alabilmek amacıyla kullanılmaktadır.

It is used in order to have protection against every kind of danger that may come from inside or outside for the mass transport areas like, airport and metrobus.

Uygulamalar Applications





Askeri Savunma Sistemleri

Military Defense Systems



Uygulama Amacı (Application Purposes)

Askeri alanlarda kuleler, sığınaklar gibi stratejik noktaların güvenliğini en üst düzeye çıkarmak için uygulanmaktadır.

It is used in order to raise the security of strategic areas like, towers in military fields and shelters to the top level.

Uygulamalar Applications



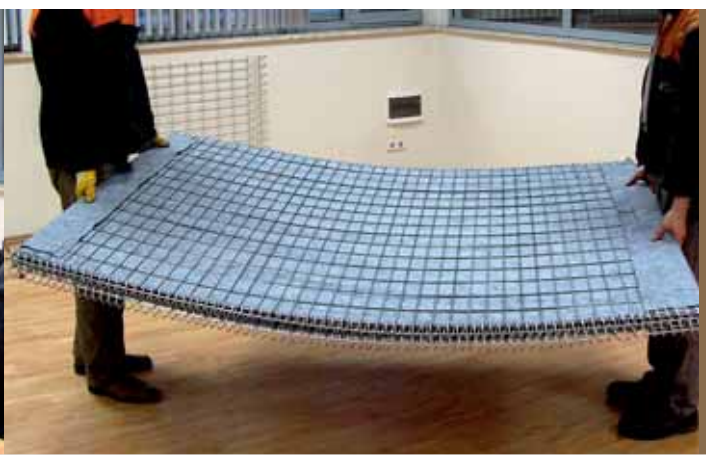
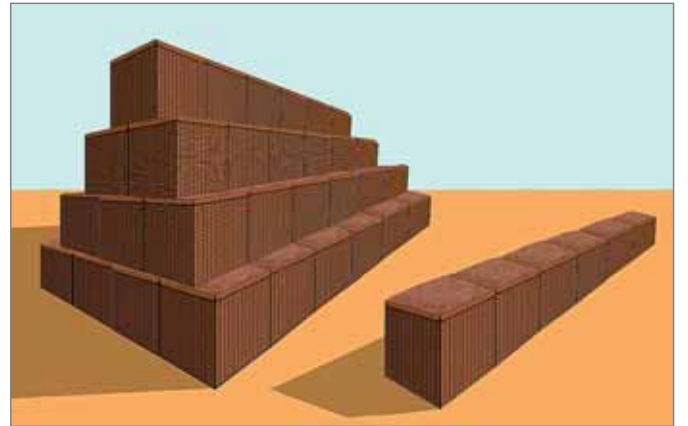
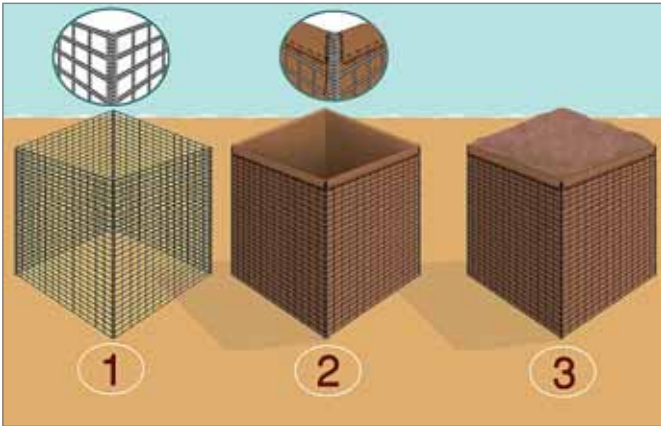

Park & Havuz Uygulamaları

Park & Pool Applications



Uygulama Amacı (Application Purposes)

Öncelikli olarak çocuklarımızın ve biz büyüklerin, güven içersinde park ve havuz gibi sosyal aktivite alanlarında emniyette olmalarını sağlamak amacıyla kullanılmaktadır.

It is used to provide safety for our children as the priority and for adults in social activity areas like park and swimming pool.

Uygulamalar Applications





Hayvan Barınak & Hara Uygulamaları

Animal Sanctuary & Stud Farm Applications



Uygulama Amacı (Application Purposes)

Hayvanlarımızın zarar görmesini ve çevreye zarar vermesini önlemek, güvenliğini ve verimli bir şekilde yaşamlarını sürdürmelerini sağlamak amacıyla kullanılmaktadır.

It is used to provide protection from damage of our livestock and to prevent them to damage the surrounds and to provide for continuation of their life in secure and efficient way.

Uygulamalar Applications





Avrupa Birliđi Hayvan Barınakları Projesi



Akaryakıt & Baz İstasyonları

Petrol & Base Stations



Uygulama Amacı (Application Purposes)

Akaryakıt ve baz istasyonları gibi yüksek tehlike arz eden bölgelerin, üst düzeyde çevre güvenliğini sağlamak amacı ile uygulanmaktadır.

It is used to provide for high level security for areas that presents high level of danger like petrol stations and base stations.

Uygulamalar Applications





Spor Saha Uygulamaları

Sport Field Applications



Uygulama Amacı (Application Purposes)

Spor sahalarında gerek sporcuların, gerekse seyircilerin faaliyetlerini sürdürürken onlara kolaylık ve aynı zamanda güvenli olmalarını sağlamak amacıyla kullanılmaktadır.

It is used in sport fields to provide comfort and security at the same time for the sportsman and the audience as well at sporting fields.

Uygulamalar Applications





Spor Saha Uygulamaları

Sport Field Applications



Uygulama Amacı (Application Purposes)

Spor sahalarında gerek sporcuların, gerekse seyircilerin faaliyetlerini sürdürürken onlara kolaylık ve aynı zamanda güvenli olmalarını sağlamak amacıyla kullanılmaktadır.

It is used in sport fields to provide comfort and security at the same time for the sportsman and the audience as well at sporting fields.

Uygulamalar Applications





Spor Çit Sistemleri
Spor Saha Ekipmanları
www.guvensporcit.com



GÜVEN | ÇELİK HASIR PANEL ÇİT SİSTEMLERİ

www.guvenclikhasir.com.tr WELDED MESH WIRE - PANEL FENCE SYSTEMS

GÜVEN ÇELİK HASIR VE PANEL ÇİT SİSTEMLERİ İMALAT SAN. TİC. LTD. ŞTİ.

SAKARYA GENEL MERKEZ (Factory)

Adres : Zirai Aletler Sanayi Sitesi Adapazarı/SAKARYA - TÜRKİYE

Telefon : +90 264 277 31 25(pbx)

Faks : +90 264 274 28 83

E-Posta : bilgi@guvenclikhasir.com.tr

İSTANBUL SATIŞ PAZARLAMA MERKEZİ (Marketing Centre)

Adres : Demirciler Sitesi 4.Yol No:37 Zeytinburnu/İSTANBUL - TÜRKİYE

Telefon : +90 212 415 36 76 - 77

Faks : +90 212 415 36 78

ANKARA SATIŞ PAZARLAMA MERKEZİ (Marketing Centre)

Adres : 41.A Sokak No:40 Yeni Mahalle Ostim/ANKARA - TÜRKİYE

Telefon : +90 312 354 50 21 - 31

Faks : +90 312 354 50 42

KOCAELİ SATIŞ PAZARLAMA MERKEZİ (Marketing Centre)

Adres : Yenişehir Mah. G.M.K. Bulvarı Konak Sokak No:41

Yahya Kaptan/KOCAELİ - TÜRKİYE

Telefon : +90 262 311 22 03

Faks : +90 262 311 22 83



Kalite Yönetim Sistemi
TS EN ISO/IEC 17021
AB-0022-YS



www.guvenclikhasir.com.tr



KOSGEB
www.kosgeb.gov.tr

Basım Tarihi: 28.02.2011 5.000 Adet Basılmıştır.
Kurumsal Hizmetler - Ömer KALEDİBİ 0533 764 57 32